

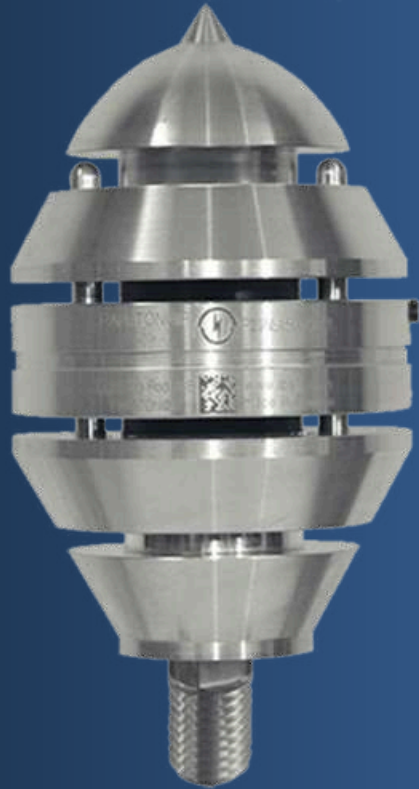

10 μ s

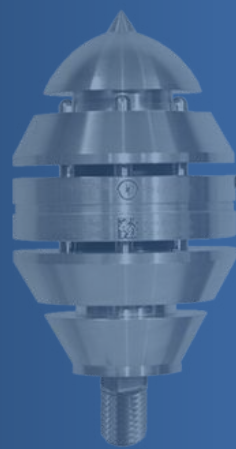

25 μ s



45 μ s



60 μ s

Paraton@ir[®] 25



Early Streamer Emitter Lightning Rod
Triggering advance : 25 μ s
Contact@ir[®] Ready



EN-10002-P25



www.lpsfr.com

See the product



Paraton@ir[®]25 Communicating Early Streamer Emitter Lightning Rod 25 μ s

The Smart Early Streamer Emitter Lightning Rod Paraton@ir[®] 25 is an evolution of the Ellips[®] ESE. Paraton@ir[®] 25 provides direct lightning protection for all structures or open spaces.

Through our Contact@ir[®] System range of transmitters and receivers, Paraton@ir[®] 25 provides rapid lightning event diagnostics for maintenance of lightning installations.

Its aesthetic allows its integration in all projects.

Characteristics :

Reference	Triggering advance	Dimensions in mm	Weight in kg	Main axis
10002	25 μ s	200x100	1,854	M20

- Material: aluminum alloy and patented polymer materials
- Compliance with NFC 17-102:2011, UNE 21186, IEC 62305 standards and equivalent country standards
- Option : communication Contact@ir[®] System

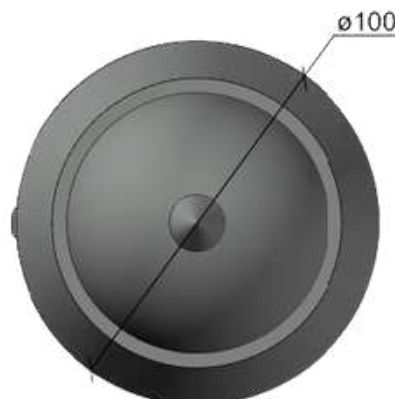
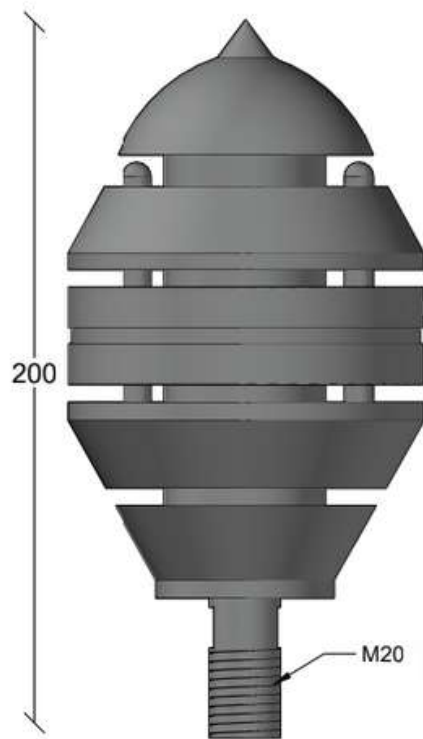

www.lpsfr.com

See the product



EN-10002-P25

EN-10002-P25

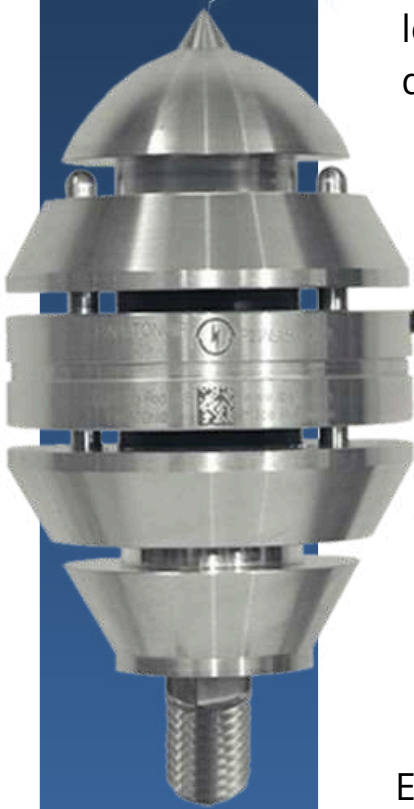

Protection radius

The radius of protection of an Early Streamer Emitter Lightning Rod is related to its height (h) in relation to the structure to be protected, its effectiveness (triggering advance) and the level of protection determined beforehand.

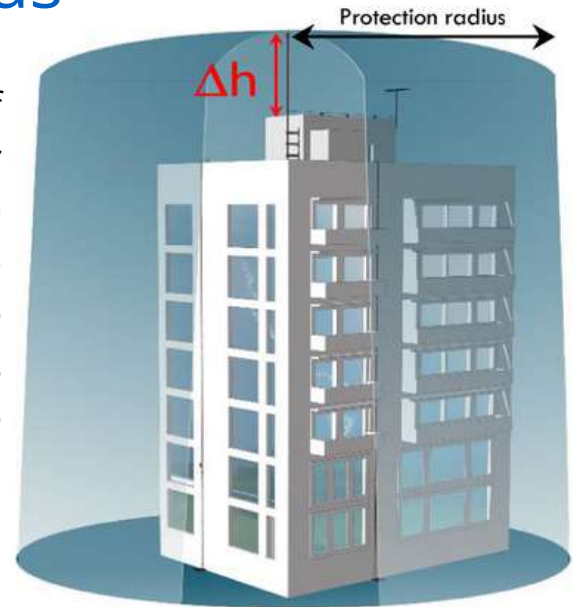

Level of protection

	I	II	III	IV
2	17	20	23	26
3	25	29	34	39
4	34	39	46	52
5	42	49	57	65
10	44	51	61	69
20	45	54	65	75
60	45	55	68	85

Radius in metres

Example: for $\Delta h = 5$ m and protection level II, then the protection radius of paraton@ir[®] 25 (triggering advance = 25 μ s) is 49 m.



www.lpsfr.com

See the product



The LPS Manager application

Allows you to simply calculate the protection level of a site and view the protection radius of the Paraton@ir[®] 25 in situation.



www.lpsfr.com

See the product



Operating

1. Paraton@ir® is charging:

The element called «charger» is designed to accumulate natural ions in the «Inductive Central System» (patented).

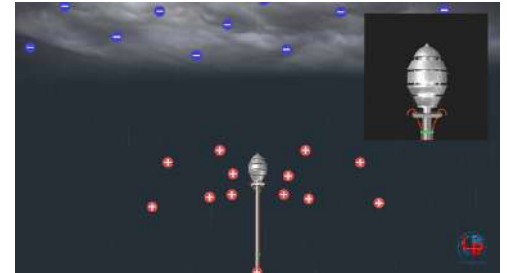

2. Paraton@ir® creates a huge electric field:

Thanks to the «Central Inductive System» and the «Booster», Paraton@ir® creates a gigantic electric field of charge opposite to that of the natural electric field present and stimulates the «Capture Head».

3. Capture and conduction by the Paraton@ir® Early Streamer Emitter Lightning Rod:

The trigger of the Paraton@ir® system attracts the descending tracer and creates the conditions for "lightning strike". The capture tip then guides the lightning current through its axis to the grounding conductors.

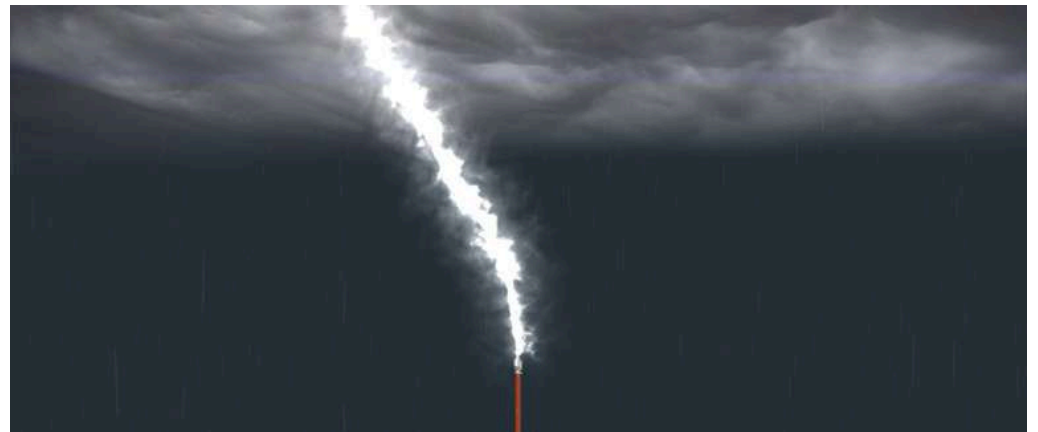
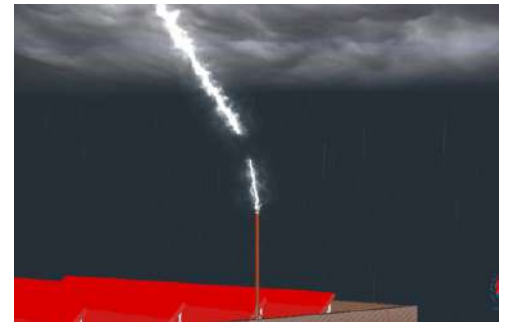

EN-10002-P25



Validation tests

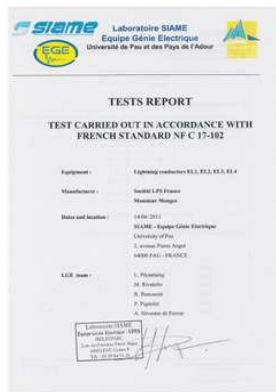
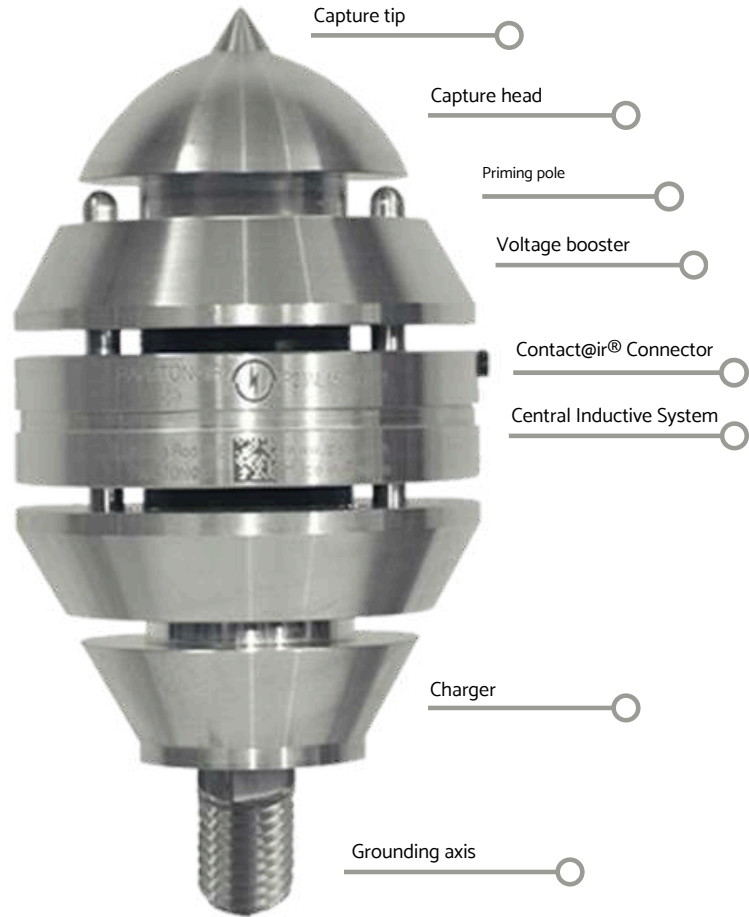

Compliant with the standards

NFC 17-102:2011
UNE 21186
IEC 62305

and to equivalent country standards

Verification tests

With contact

Without contact

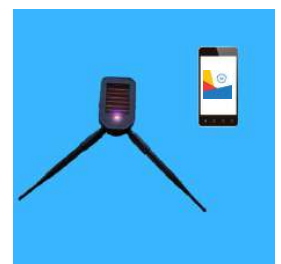
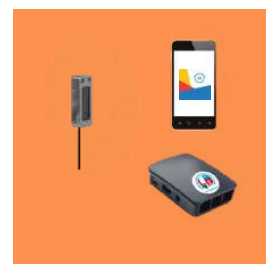
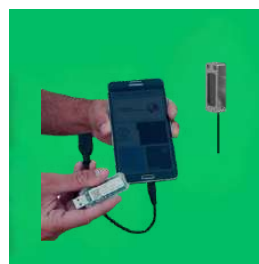

Test@ir®

Contact@ir®
+
Dongli@ir®

Contact@ir®
+
Rout@ir®

Contact@ir® MD

With travel

Without travel



www.lpsfr.com

See the product





EN-10002-P25

Positioning :

1000* : Paraton@ir[®]

22041 : Conductor

10012 : Lightning rod-conductor connection

11121 : Elevation mast 1st element

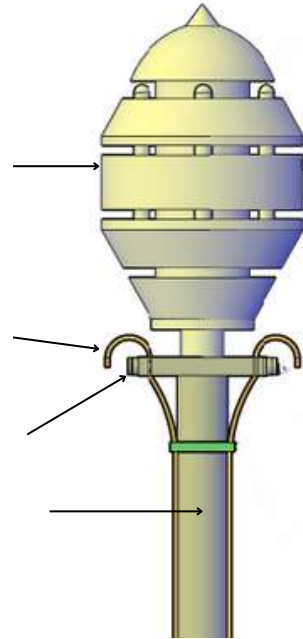

1000* :
Early Streamer Emitter lightning rod
Paraton@ir[®] range

500** :
Option Contact@ir[®]

10012 :
Lightning rod-conductor
connection

11121+ 11221 + 11321 :
Set of elevation masts

11531 :
Masts fastenings

43601 :
Aerial mast diverter

43101 : Concrete-PVC block

22041 :
Downward conductors

43107 ou 43108
ou 43231 +43301 :
Downward conductor fastenings

34348 :
Ground spike/conductor lug

34843 :
Ground spikes

Your smart maintenance

Throughout the life of your lightning protection installation:

- Easily perform installation checks
- Meet standard maintenance requirements
- Preserve your manufacturer and installer warranties
- Ensure your safety
- Manage your installation from the LPS Manager application

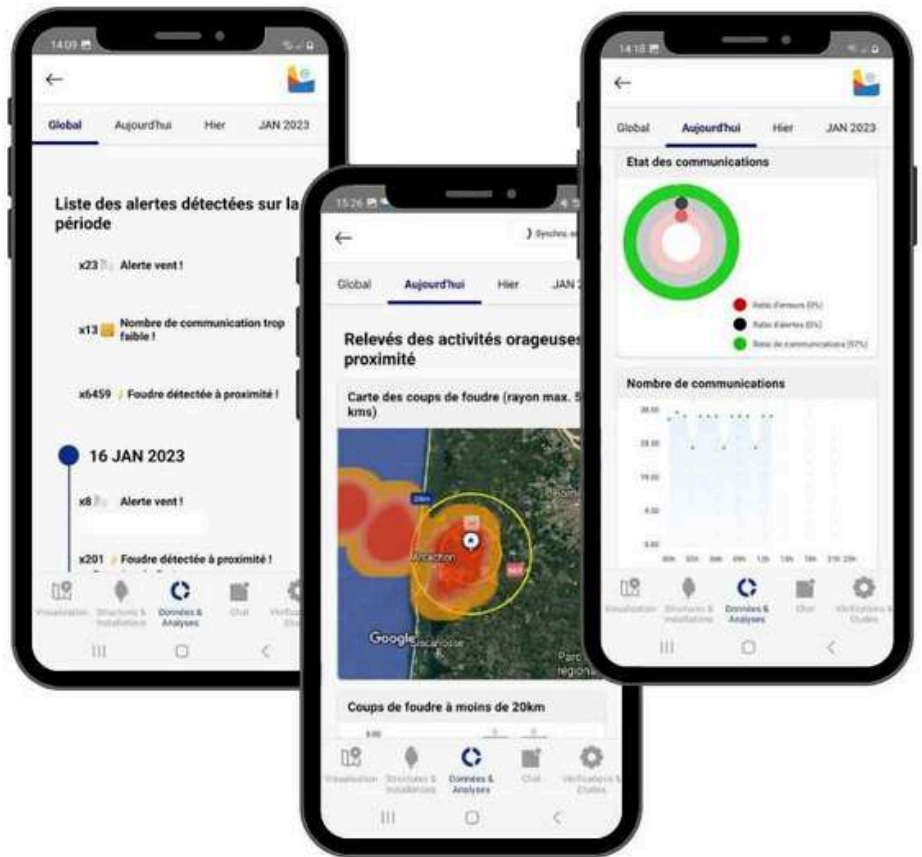

www.lpsfr.com

See the product



lpsmanager.io



EN-10002-P25

Contact@ir[®] option : Remote Testing and Permanent Monitoring

- Working condition of the product
- Authenticity of the product
- Real-time alerts (lightning strikes, current measurement, product defect)
- Historization of information
- Management in the LPS Manager application

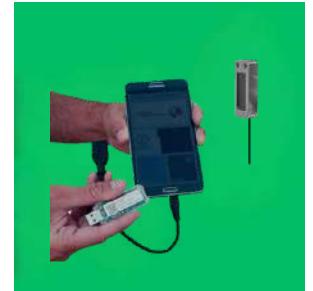
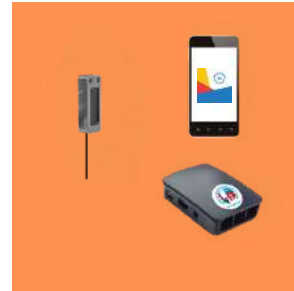
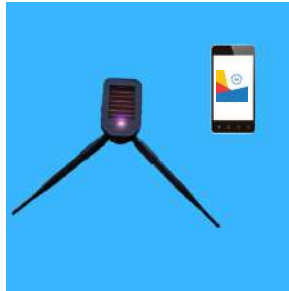

Contact@ir[®] MD

Contact@ir[®]
+
Rout@ir[®]

Contact@ir[®]
+
Dongl@ir[®]

Identification of the product

✓

✓

✓

Product test

✓

✓

✓

In real time alerts

✓

✓

✗

History

✓

✓

✗

Connectivity

✓

✓

✗

Autonomous power supply

✓

✗

✗

www.lpsfr.com

See the product



Contact@ir[®] System



EN-10002-P25

EN-10002-P25



Monitor any lightning installations with Contact@ir® System

New or old installation, all brand, Choose:

ESE



Paraton@ir®



Compt@ir®



Alert@ir XT®

Example: for a new installation that requires remote monitoring, choose Paraton@ir® + a Contact@ir® System solution.

New or old installation, choose:

Simple Rod



Meshed cage



Tensioned cables



Compt@ir®



Alert@ir XT®

Example: for an existing installation of any kind, choose Compt@ir® or Alert@ir® XT + a Contact@ir® System solution.



www.lpsfr.com

See the product



Contact@ir® System

